

2-Bay RAID System for 3.5" SATA HDD

Streamlines Storage Management Easily



USB 2.0
eSATA
FireWire 400
FireWire 800

User's Manual



Table of Contents

GENERAL INFORMATION	4
COPYRIGHT	4
NOTICES AND CLASSIFICATIONS	4
CONTACT US.....	4
INTRODUCTION.....	6
FEATURES.....	6
SYSTEM REQUIREMENT.....	7
<i>PC</i>	7
<i>MAC</i>	7
OPTIONAL ACCESSORIES	7
PACKAGE CONTENTS	7
SYSTEM UNIT VIEWS	8
FRONT VIEW	8
REAR VIEW.....	8
TOP & COVER VIEW (EXPOSED)	9
INSERTING/REPLACING THE HARD DRIVES IN THE RAID SYSTEM.....	10
CONNECTING THE RAID SYSTEM TO A COMPUTER.....	16
CONNECTING MULTIPLE DEVICES.....	18
RAID MODES.....	19
RAID 0 (STRIPING).....	20
RAID 1 (MIRRORING)	21
JBOD.....	22
SETTING THE RAID MODE (MANUALLY).....	23
RAID SWITCH.....	24
HDD SLOT NUMBER	25
HDD ALLOCATION	25
LED INDICATORS	26
POWER LED x 1	26
HDD LED x 4	26
SAFE REMOVAL OF THE RAID SYSTEM	27
EXTERNAL BOOTUP	28
<i>PC</i>	28
<i>MAC</i>	28
<i>Disk Volume Over 2TB</i>	28
ESATA PCI EXPRESS CARD INSTALLATION.....	29
SYSTEM REQUIREMENTS.....	29
HARDWARE INSTALLATION.....	29
DRIVER INSTALLATION	30
VERIFY DRIVER INSTALLATION	30
<i>Mac OS:</i>	30
<i>Windows OS:</i>	30
<i>Windows 2003 and XP:</i>	31

<i>Windows 2000:</i>	31
Q&AS	32
GENERAL.....	32
HDD CAPACITY	32
DISCREPANCY IN REPORTED & ACTUAL SIZE CAPACITY.....	33
HDD ALLOCATION.....	33
RAID 0	34
JBOD.....	34
APPENDIX: SPECIFICATIONS	35

GENERAL INFORMATION

COPYRIGHT

Copyright © 2009 ONNTO Corporation. All rights reserved. No part of this publication may be reproduced, stored in a retrieval system, or transmitted in any form or by any means, electronic, mechanical, photocopying, recording or otherwise, without the prior written consent of ONNTO Corporation.



The product information provided in this manual is subject to change without prior notice and does not represent a commitment on behalf of the vendor. The vendor assumes no liability or responsibility for any errors that may appear in this manual.

NOTICES AND CLASSIFICATIONS

FCC-B Radio Frequency Interference Statement

This device complies with Part 15 of the FCC rules. Operation is subject to the following two conditions:

This device may not cause harmful interference.

This device must accept any interference received, including interference that may cause undesired operation.



This equipment has been tested and found to comply with the limits for a Class B digital device, pursuant to Part 15 of the FCC rules. These limits are designed to provide reasonable protection against harmful interference when the equipment is operated in a commercial environment. This equipment generates uses and can radiate radio frequency energy and, if not installed and used in accordance with the instruction manual, may cause harmful interference to radio communications.

CONTACT US

We are committed to offer economical, high-quality connectivity and storage enclosure solutions to the market. Your questions, inquiries or comments are welcomed. For Technical Support, please go to our website at

www.onnto.com.tw

ONNTO Corporation

3F, No. 60, Lane 321, Yang Guang St.,

Nei Hu, Taipei 114 Taiwan

Tel: +886-2-8797-8868

Fax: +886-2-8797-4801

Email: question@onnto.com.tw



PRECAUTIONS FOR THE RAID SYSTEM

- ◆ **Any loss, corruption, or destruction of data is the sole responsibility of the user of the RAID Unit. Under no circumstances will the manufacturer be held liable for the recovery or restoration of any data.**
- ◆ The main circuit board of the RAID System is susceptible to static electricity. Proper grounding is required to prevent electrical damage to the RAID System unit or other connected devices, including the host computer. **Always** place the RAID System unit on a smooth surface and avoid all dramatic movement, vibration and percussion.
- ◆ Do **NOT** allow water to enter the RAID System unit.
- ◆ Installation of additional equipment in the host computer may be required. Visit our website to download the latest product information updates.
- ◆ Do **NOT** attempt to service this unit yourself. Disassembling the RAID System's inner parts will expose you to dangerous voltages or other hazards.
- ◆ Do **NOT** block the ventilation. Proper airflow is required to ensure reliable operation and to prevent overheating.
- ◆ Do **unplug** the RAID System unit from the electrical outlet when not in use to provide an ecological friendly environment.
- ◆ **Use only** the power supply cable provided with the RAID System unit.

INTRODUCTION

Thank you for purchasing the DataTale 3.5" SATA HDD 2-bay RAID System. The DataTale 3.5" SATA HDD 2-bay RAID System provides massive storage capacity and advanced RAID configuration options in a desktop storage device. The RAID Mode Switch allows easy configuration of RAID 0 (Striping), RAID 1 (Mirroring), and JBOD (Just a Bunch Of Disks) RAID modes.



Please thoroughly read and follow the instructions provided in this manual. Failure to do so may result in damage to the RAID System, and any or all of the connected devices.

Features

- ✚ Supports current SATA II compliant HDDs, fully backward compatible with SATA 1.0 and SATA 1.0a compliant HDDs
- ✚ Connects flexibly via an eSATA, USB 2.0, 1394a or 1394b port
- ✚ Provides RAID 0 (Striping), RAID 1 (Mirroring), and JBOD (Just a Bunch Of Disks) for effective storage management
- ✚ Configures RAID modes easily using switches, no IT expertise required
- ✚ Simplifies RAID management, no software installation required
- ✚ Monitors system status via LED indicators
- ✚ Prevents over-tightened HDDs with auto-limiting segmented screws
- ✚ Features a trayless function with the SmartGuider and the user-friendly design enables effortless HDD hot-swapping
- ✚ Dissipates heat efficiently with aluminum housing
- ✚ Maximizes airflow with silent fans and mechanical designs
- ✚ Supports hot-plug and HDD hot-swap
- ✚ Supports both online and offline rebuild



Any loss, corruption, or destruction of data is the sole responsibility of the user of the RAID System. Under no circumstances will the manufacturer be held liable for the recovery or restoration of any data.



SmartGuider is a trayless device that utilizes the simplicity of a handle and screws. The integrated handle is attached to the HDD with auto-limiting segmented screws. Then, the entire setup can be slide into the unit by aligning the screws with the specially designed guides. This enables flexibility in removal and insertion of the HDDs with ease.

System Requirement

To use the 2-Bay RAID System, the minimum system configuration in the host computer require the following:

PC

- ✚ 266MHz or faster CPU (Windows Vista requires a minimum 800MHz CPU)
- ✚ 64MB of RAM (Windows Vista requires 512MB of RAM)
- ✚ Microsoft Windows 2000, XP, 2003, or Vista
- ✚ One available eSATA port, USB 2.0, IEEE 1394a, or IEEE 1394b port (Depend on model)

MAC

- ✚ Macintosh PowerPC or Intel Core Duo processor
- ✚ 64MB of RAM (Mac OS X 10.4 requires 256MB of RAM)
- ✚ Mac OS X 10.2 or higher (PowerPC) or Mac OS X 10.4 (Intel) or higher
- ✚ One available eSATA port, USB 2.0, IEEE 1394a, or IEEE 1394b port (Depend on model)

 3.5" SATA compatible hard drive is required for the RAID System. Once the HDDs are formatted, the actual available storage capacity can vary depending on the selected operating environment (normally 5-10 % less).

Optional Accessories

- ✚ eSATA PCI, PCI-X, or PCI-Express Card

Package Contents

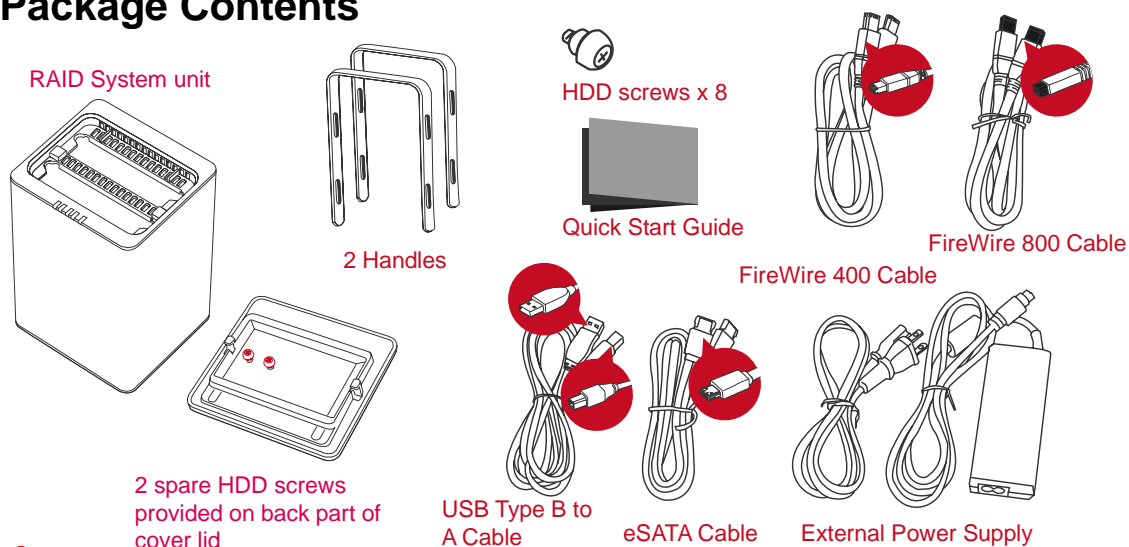

 Please keep all package contents and packaging material in the event that the product must be returned.

SYSTEM UNIT VIEWS

Front View

1 LED Indicators

 The status indication of each LED indicator is listed under the LED INDICATORS section.

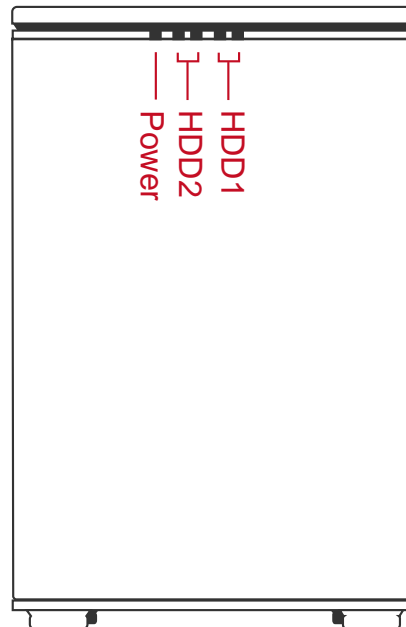

Rear View

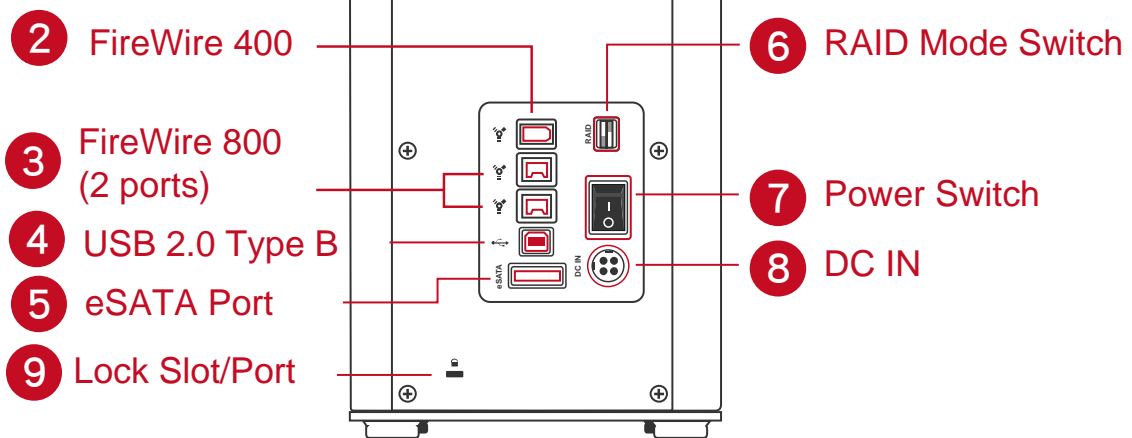

Top & Cover View (Exposed)

10 "Front" Indicator

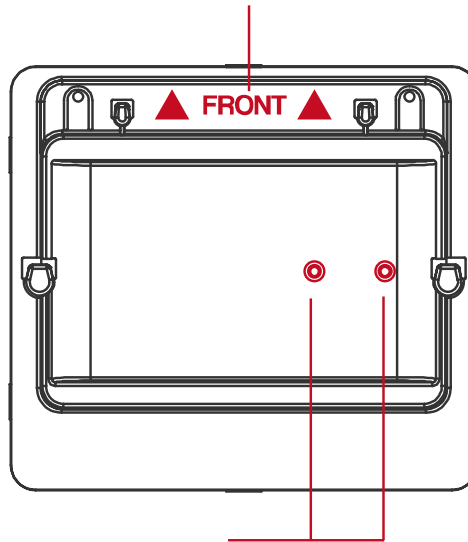

11 2 Spare HDD Screws

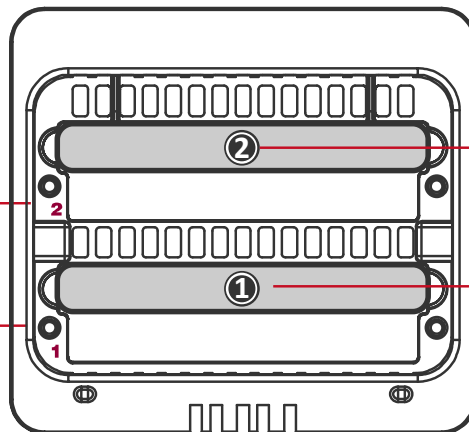

12 HDD Slots
(indicates HDD 1
through HDD 2)

13
Handles

INSERTING/REPLACING THE HARD DRIVES IN THE RAID SYSTEM

1. Place the RAID System with its front view facing you. Position both hands on the front edge. Simultaneously, push the lid in the direction away from you, front to back, using your thumbs.

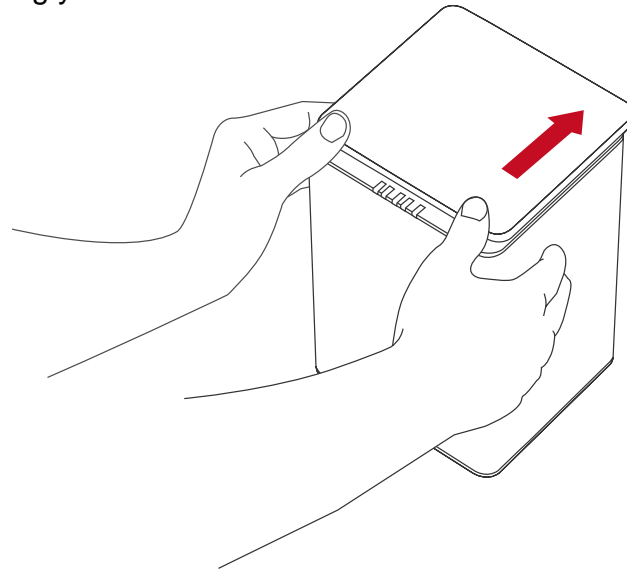

A “click” sound would indicate the release of the top lid security clasp.

2. Lift the top lid up to remove and expose the top view (or HDD slots). Take out the handles from the enclosure itself and locate the HDD screws in the packaging box.

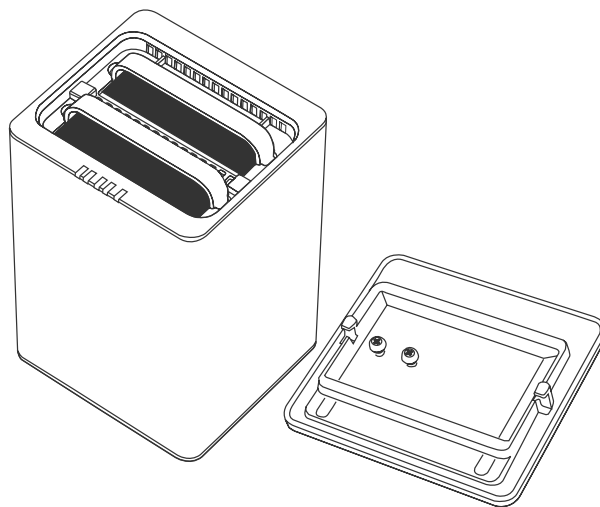

(Fasten the Handles on HDDS)

3. Place the HDD with the metal cover side facing up and ensure that the interface connectors are oriented toward your left side.

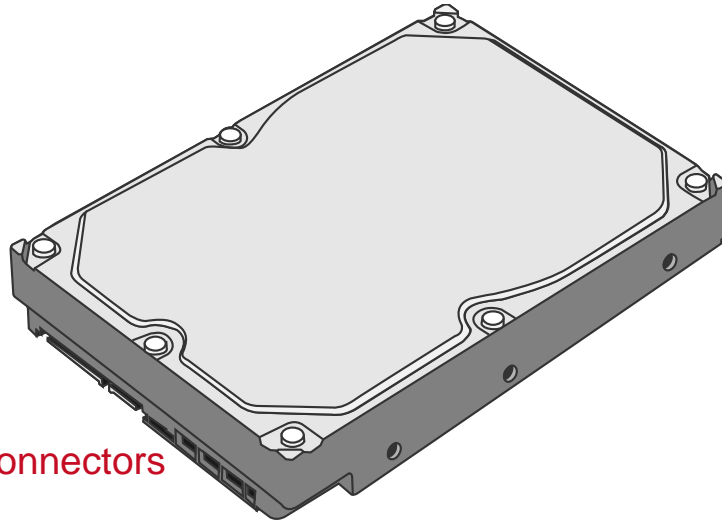

Connectors

4. Position the handle to the HDD end, which is facing away from the interface connectors, and align it with the screw hole openings.

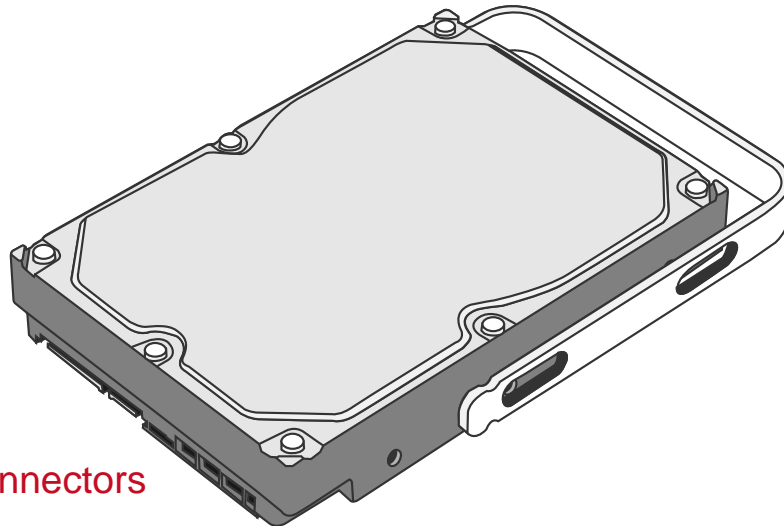

Connectors

5. Fasten the handle onto the HDD by inserting and tightening the screws, the left one first, then the right one.

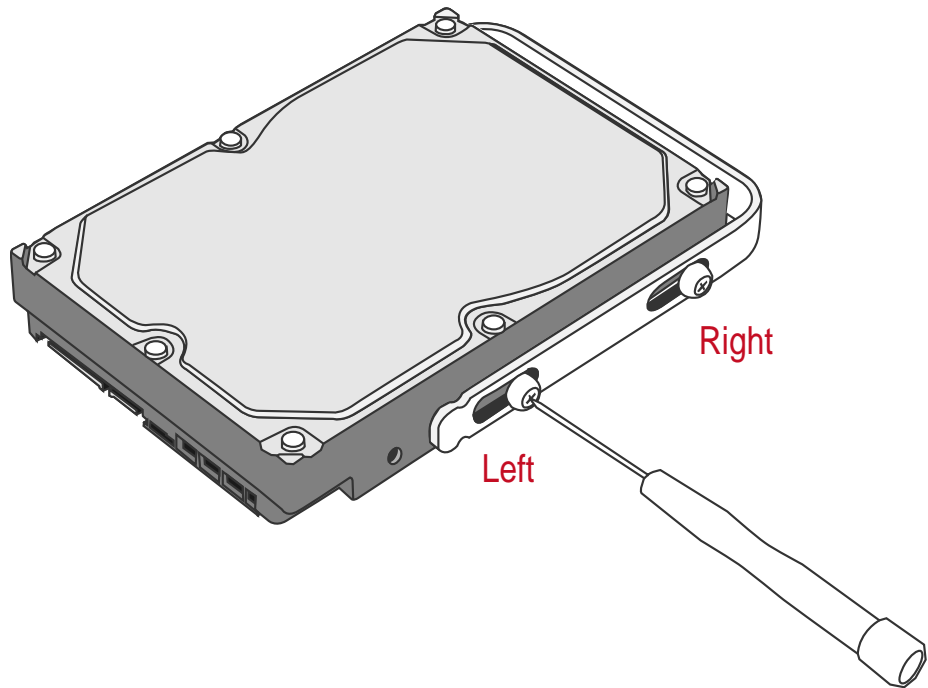

6. Now, flip the HDD so it is facing you with the PCBA (Printed Circuit Board) on top and the unfasten handle side facing you.

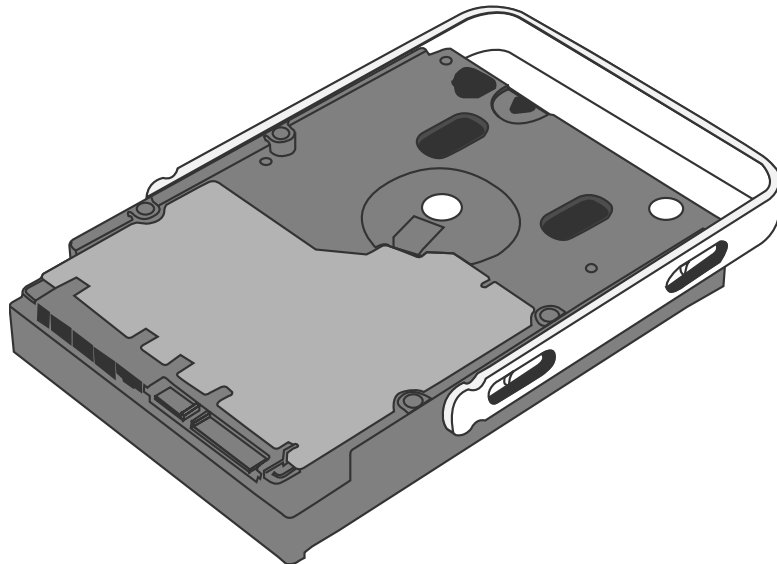

7. Insert and tighten the screws, the left one first, then the right one.

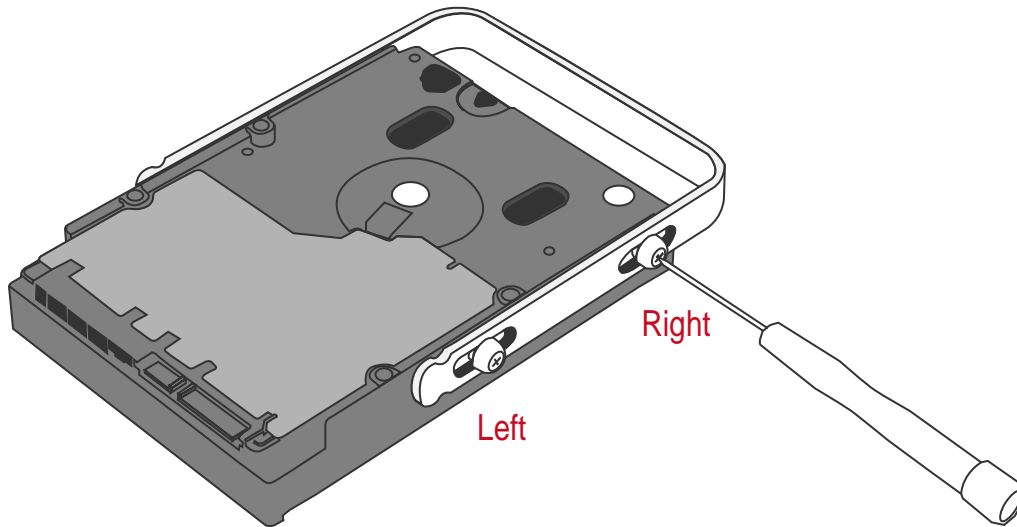

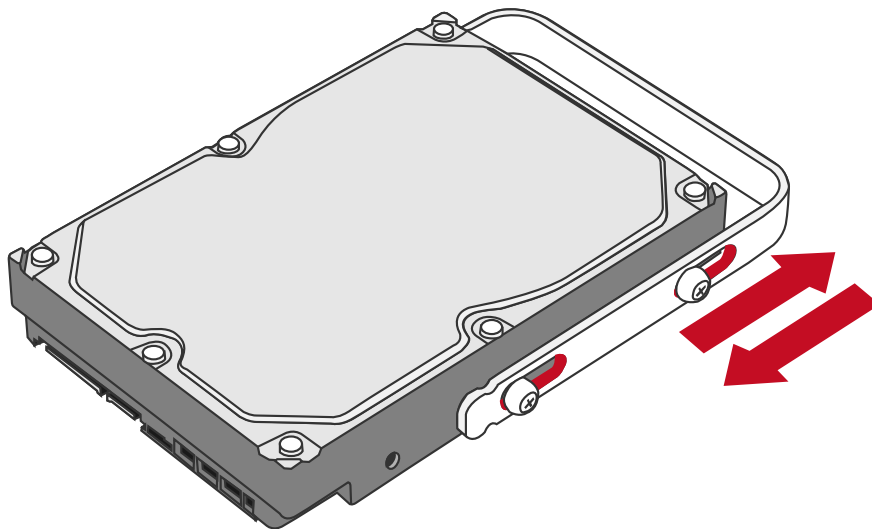

8. Finally, test sliding the handle to make sure the holes glide smoothly on the screw guides. Repeat the same procedures for the second HDD.

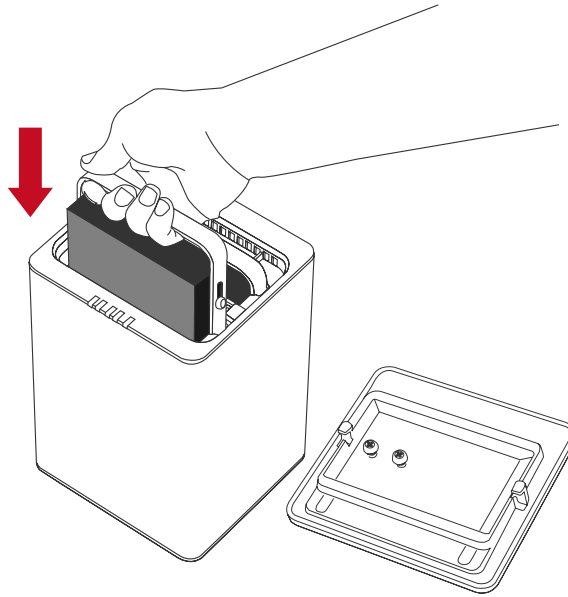

 The auto-limiting segmented screws are designed to prevent the HDDs or/and the handles from damages due to over-tightening. Furthermore, this design makes the handle slide easily without any tightness.

9. Hold the HDD with the metal cover side facing you and the handle attached on the upward position.



 When inserting the HDD on its reverse side, the SmartGuider System won't be able to align and the HDD cannot be inserted.

10. Align the handle with the guide rails and slide the HDD into the indicated slot. Firmly push downward until a “thump” sound is heard. Repeat the same procedures for the second HDD.

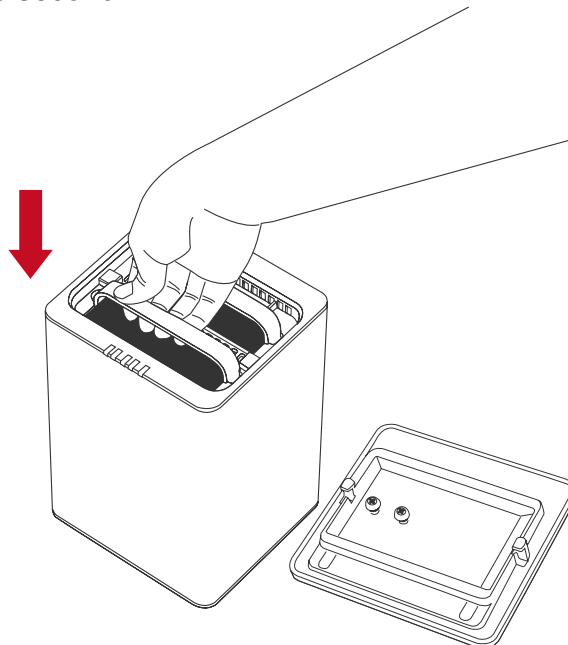

 In most cases, you would need to firmly push the HDDs to a close until a “thump” sound is heard.

11. Place the RAID System with its front view facing you and the top lid on. Position both hands on the back edge of the top lid. Simultaneously, push the lid firmly downward and toward you, back to front.

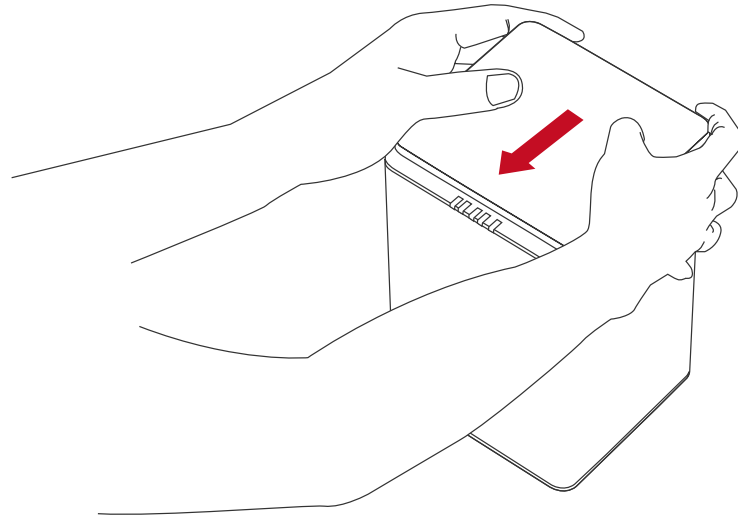

 A “click” sound would indicate grasp of the top lid security clasp.

12. Now, the RAID System is ready for connection to a computer!



CONNECTING THE RAID SYSTEM TO A COMPUTER

Complete the following steps to connect the RAID System to a host computer.



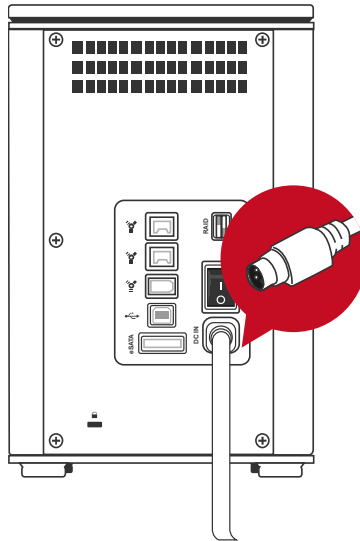

The RAID System should only be connected to a host computer via one interface. Connection of the system to a computer via two or more interfaces simultaneously is not recommended.

1. Connect the AC/DC power adapter.

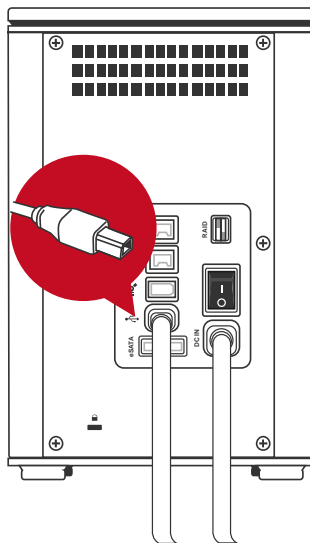

2. Insert both ends of the USB 2.0, eSATA, FireWire 400, or FireWire 800 cable(s) into the corresponding port of the RAID System and the host.



-  It is highly recommended to select only one interface to do data transfer.
3. Turn the power switch to the “on” position.

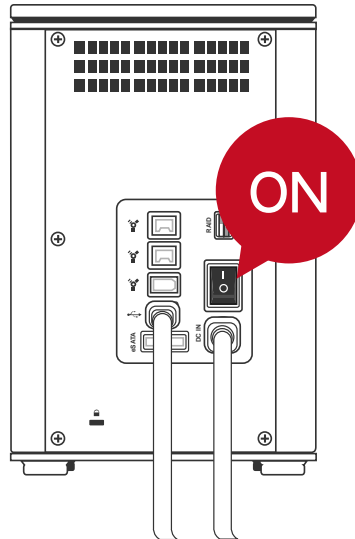

4. When connected, the Power LED light will become steadily green, and the HDD LED lights will become white and blink about 15 seconds. If the HDDs are inside the RAID System, the HDD LED lights will remain steadily white. If there are no HDDs inside the RAID System, the HDD LED lights will turn off after blinking.

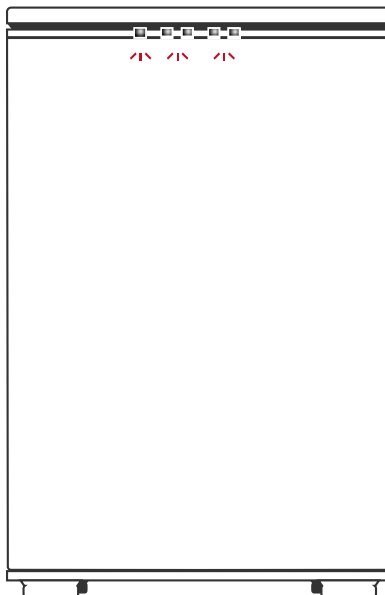

5. You are now ready to begin using your RAID System!

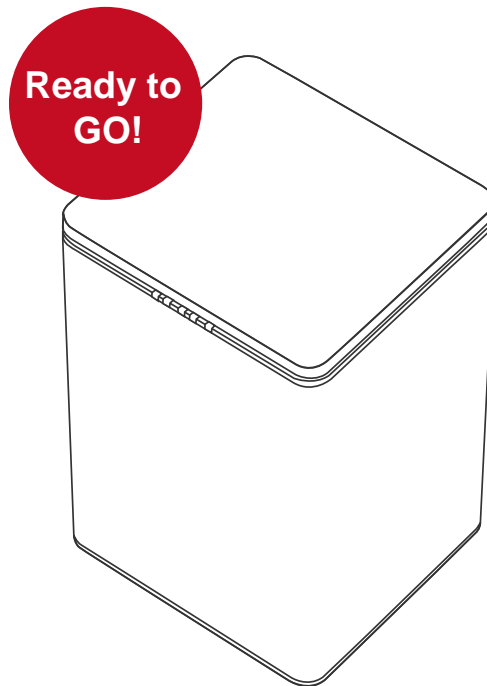

Due to compatibility issues, if you use the eSATA interface to do the data transfer, the Silicon Image eSATA host controller is highly recommended.

Connecting Multiple Devices

Using FireWire 400 or 800, you can connect other computer hardware or digital devices to your RAID System. This connection is called “Daisy chain”. Items connected to the RAID System may be such as digital video camera, another HDD, DVD writer, and much more. However, you must use the same interface in order for the Daisy Chain to work. The computer will not recognize different interfaces if they are all used at the same time. In addition, if a mix of connections is used, the resulting speed will be limited to the lowest one available.



When an additional FireWire connector is plugged in, the connector will be viewed as a “daisy chain” port. When an additional USB or eSATA connectors is plugged in, the connector will be viewed as its originate port, either USB or eSATA respectively.

RAID MODES

A Redundant Array of Independent (or Inexpensive) Disks (RAID) is a system that utilizes multiple hard drives to share or replicate data among the disks. The benefit, depending on the selected RAID Mode (combinations of disks), is one or more of increased data integrity, fault-tolerance, throughput or capacity when compared to single drives.



Deleting the current partition prior to changing RAID modes is highly recommended.





Using identical HDDs with the same capacity and RPM, and from the same manufacturer are highly recommended for best capacity utilization.

RAID 0 (Striping)

RAID 0 (Striping) is a performance-oriented, non-redundant data mapping technique. It combines multiple hard drives into a single logical unit. Instead of seeing several different hard drives, the operating system sees only one large drive. Striping splits data evenly across two or more disks simultaneously, dramatically increasing performance.

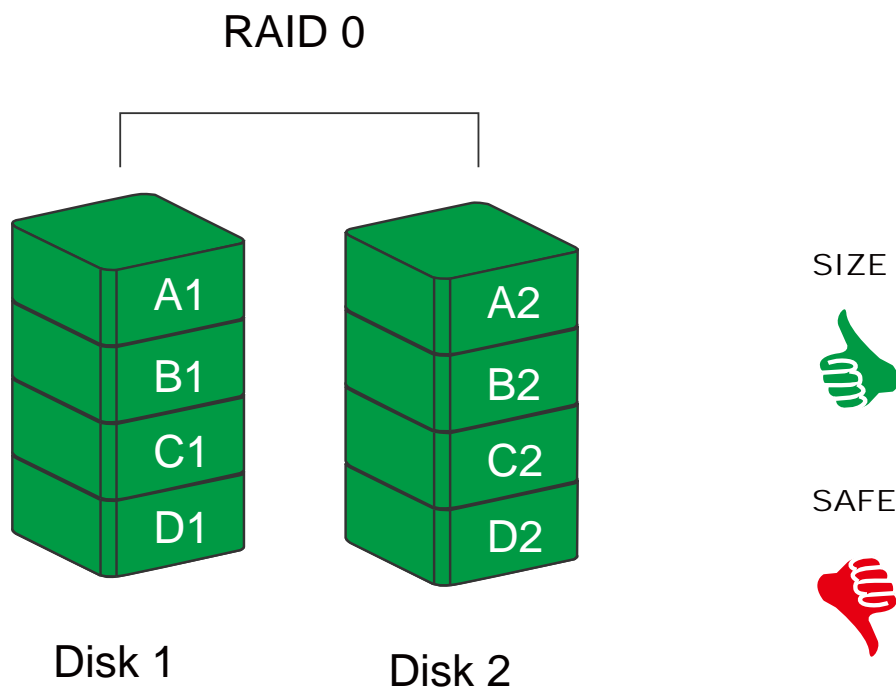
Striping can be implemented in disks of differing sizes, but the storage space added to the array by each disk is limited to the size of the smallest disk. Although Striping is an easily implemented and simple configuration, Striping should never be used for mission critical applications. The speed of operation is fast in comparison to other RAID modes.



 In Striping mode, if one disk in the RAID System fails, all data in both installed disks will be lost.

 When operating under Striping mode, it is not recommended to do HDD **Hot Swap**. Any attempt to do so may result in complete loss of all data.

RAID 1 (Mirroring)

Mirroring (RAID 1) consists of at least two drives storing duplicate copies of the same data. In this mode, the data is simultaneously written to two disks. Thus, the storage capacity of a two-disk array is combined into a single disk and the capacity is limited to the size of the smallest disk. The speed of the operation is very slow in comparison to other RAID modes.

During rebuild, the first HDD inserted into one of the HDD slots and is recognized by the RAID System as the source HDD. To rebuild existing data from a source HDD to a backup HDD (target HDD), the source HDD must first be inserted into one of the HDD slots. After the host detects the source HDD, the target HDD should then be inserted in the other HDD tray. The RAID System will then recognize the target HDD, the rebuild process will begin when the HDD LED starts blinking.

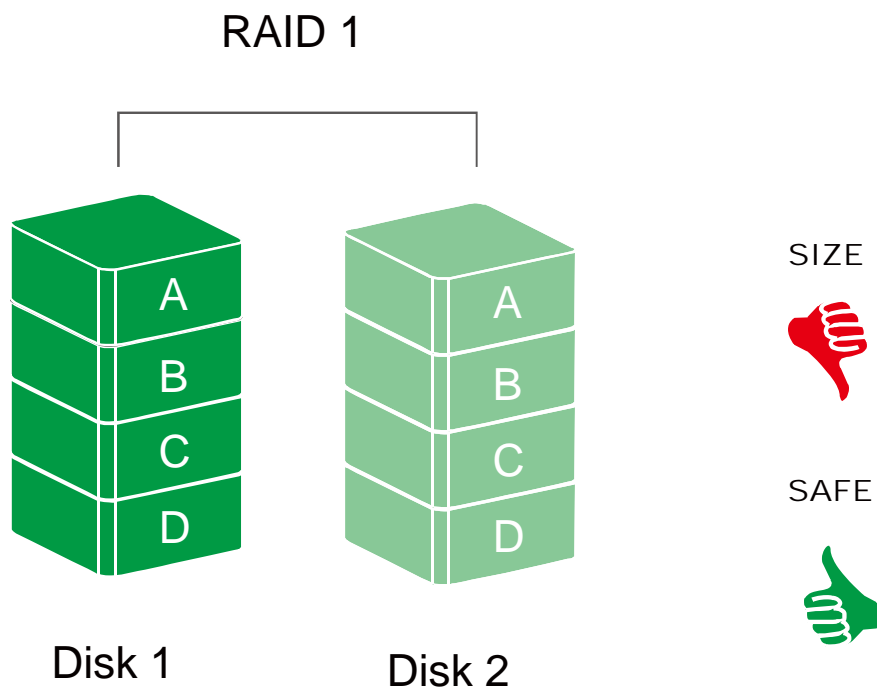

 In Mirroring mode, if one of the disks fails, either source or backup, the data is still available in the healthy disk. However, if the source disk fails during the rebuild process, the data in the backup disk will be lost.

 It is NOT recommended to do **hot swap** for the source disk during the rebuild process because the data in both disks will be lost.

JBOD

Just a Bunch of Disks (JBOD) refers to a group of hard drives. In JBOD, the number of logical drives is equal to the number of physical drives. This mode allows the RAID System to operate as a multi-disk storage enclosure, but provides no data redundancy.

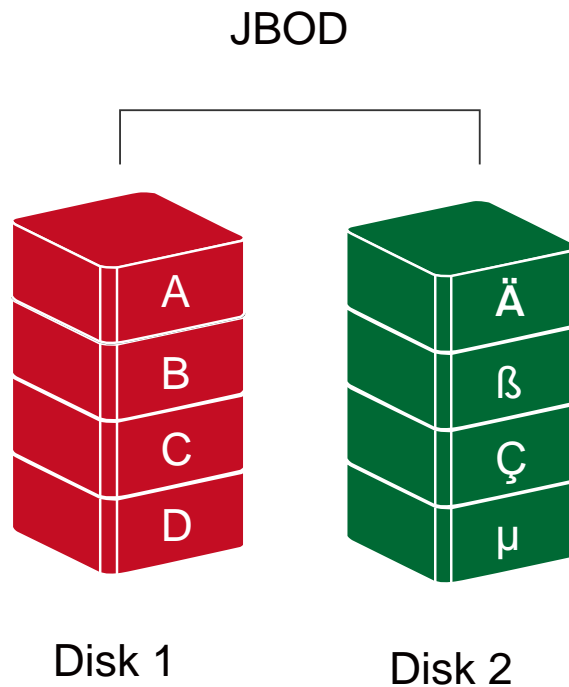

Due to the chipset limitations, only cold hot swap is allowed in JBOD mode. Therefore, the RAID System must be powered off when replacing any of the HDDs in the System.



The eSATA interface cannot support the JBOD mode. It is only available when connecting under the USB 2.0, FireWire 400, and FireWire 800 interfaces.



Due to the chipset design, when performing JBOD and only one HDD is used, always insert it into the HDD 2 of the HDD slots.

SETTING THE RAID MODE (MANUALLY)



Changing the RAID Mode deletes all data stored on the device. If you have saved data in the drives, backup all data before changing the RAID Mode.

1. Power “off” the RAID System.

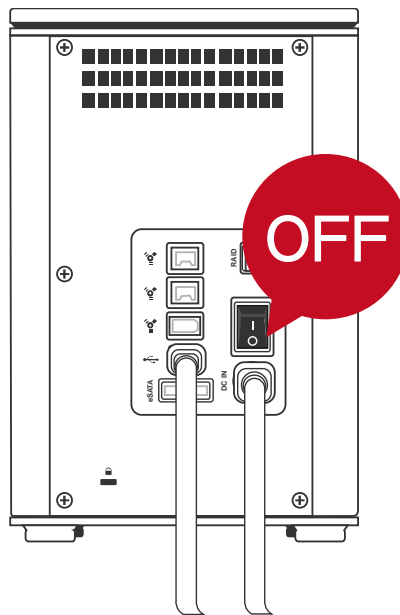

2. Use a small, flat-blade screwdriver to select the RAID Mode (RAID Switch).

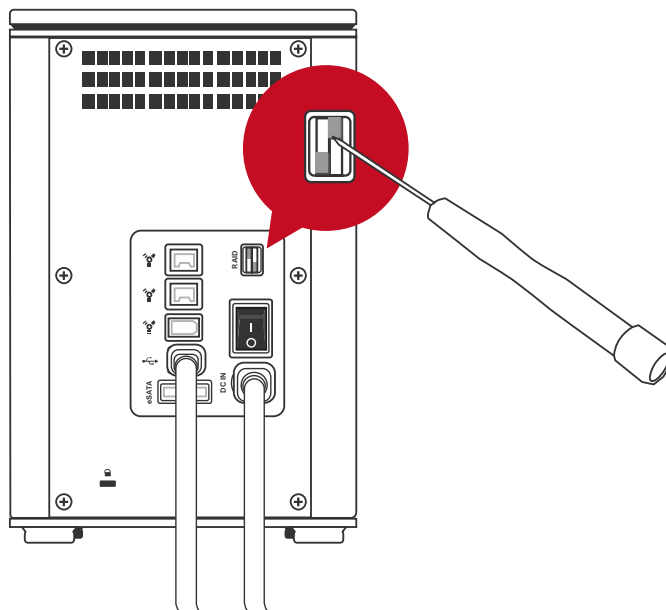

3. After setting the new RAID mode, power the RAID System “on”.

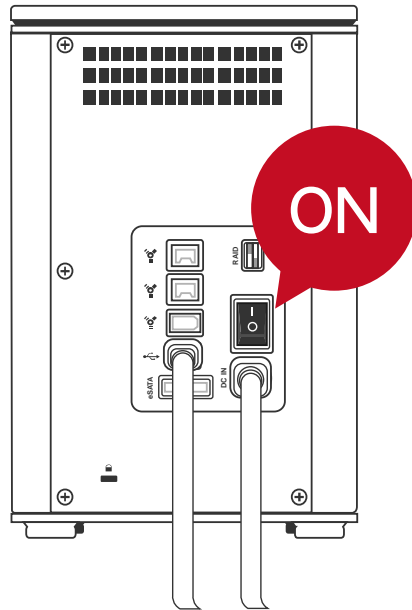

 It is highly recommended to always power off the RAID System before setting or changing the RAID Mode Switch to ensure the changes are accepted by the System.

RAID Switch

RAID 0 (Striping)



RAID 1 (Mirroring)



JBOD



HDD SLOT NUMBER

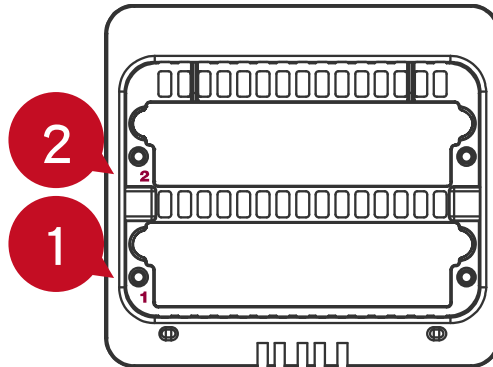

HDD ALLOCATION

It is highly recommended to use the numbering stickers provided in the package to help identify the HDD allocation. Although the HDD slots can help with organization, when the hard disks are pull out without remembering their arrangement order, the data may be lost if the HDD allocation is not the same as the one originally set in the RAID System.

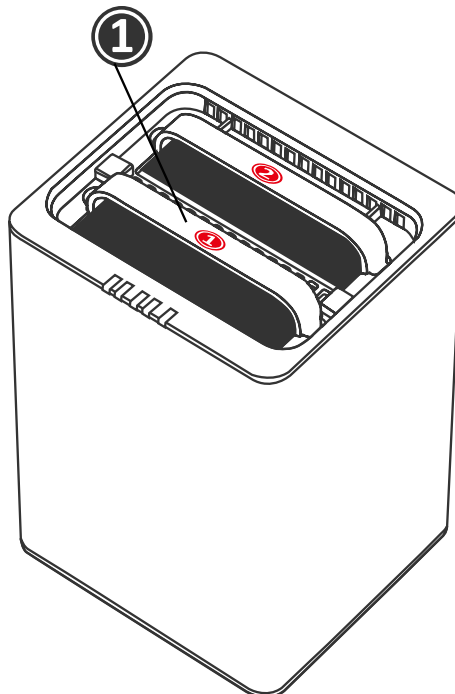

LED INDICATORS

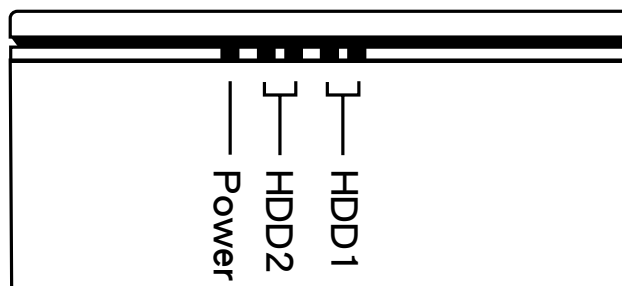

Power LED x 1

Indicators	Color
Power on	Green
Power off	None

HDD LED x 4

There are 2 LEDs for each HDD slot. The left LED indicates “Connection” and the right one indicates “Health/Access”.

The Connection LED is only one-color (white). When the HDD is connected, the white LED will be on. The Connection LED also indicates HDD power status and disk rebuild status. When the target HDD is being rebuilt, the white LED will blink.

The Health/Access LED is dual-color (red/blue). The red color is for Health condition. The blue color is for Access condition. When the HDD is not healthy, the red LED will be on. When the HDD is being accessed, the blue LED will flash. When HDD is healthy and not being accessed, no LED color will be on.

Indicator		HDD (1, 2)			RAID mode
		Left (Connection)	Right		
			Color 1 (Health)	Color 2 (Access)	
Disk error		None	Red	None	RAID 0, RAID 1, JBOD
Data access		White	None	Flash Blue	RAID 0, RAID 1, JBOD
Disk Rebuild	Source HDD	White	None	Blue	RAID 1
	Target HDD	Blink White	None	Blue	RAID 1



The difference between a flashing LED and a blinking LED is that flashing refers to the read/write activity and blinking refers to slow but regular pulses.

SAFE REMOVAL OF THE RAID SYSTEM

Safe removal of the Enclosure from the host controller is highly recommended, especially when switching interfaces. In order to safely remove your Enclosure from the host controller, you would need to eject the device on your host controller system.



If using a Mac System, safe removal of the Enclosure from the host for all interfaces is necessary.



If using a PC System, safe removal of the RAID System from the host depends on the interface. Most current USB and FireWire host controllers handle USB and FireWire devices as external devices; thus, it is highly recommended that the Enclosure be safely removed from the host if you are using either one of the interfaces. However, if you are using the eSATA interface, depending on the eSATA controller, the host may handle external eSATA HDD devices as internal HDD devices. If so, safe removal of the Enclosure from the host is unnecessary.

EXTERNAL BOOTUP

External Bootup may be required if the user has two different operating systems set up in both the host computer and the RAID System.

PC

The External Bootup with different interface:

OS \ Interfaces	USB 2.0	FireWire	eSATA
Windows	No	No	Yes
DOS	Yes	No	Yes
Linux	No	No	Yes

MAC

The External Bootup varies with different platform and interfaces:

Platform \ Interfaces		USB 2.0	FireWire	eSATA	
				Mac driver Built-in	No Driver Built-in
Power PC CPU (G4 or Later)		No	No	Yes	No
Intel-based CPU	CoreDuo	Yes	No	Yes	No
	Core2Duo Or Later	Yes	Yes	Yes	No



If the computer does not come with eSATA interface and an optional eSATA card is added, choosing the card that comes with the built-in driver in the operation system is highly recommended.

Disk Volume Over 2TB

The 2+TB HDD support is determined by the chipset used in the device and the operating system itself. The RAID System supports and recognizes 2+TB HDDs, but the actual 2+TB support will vary depending on the different operating systems used.

	OS	USB	FireWire	eSATA
Windows	Windows 2000, XP, or older	No	No	No
	Windows XP 64-bit, Windows 2003 32-bit/64-bit (SP1 and SP2)	Yes	No	Yes
	Windows Vista, Windows 2008 32-bit/64-bit	Yes	Yes	Yes
Linux	Linux 32-bit/64-bit	No	No	No
Mac	Mac OS 9/10.1/10.2	No	No	No
	Mac OS 10.3/10.4/10.5	Yes	Yes	Yes

eSATA PCI EXPRESS CARD INSTALLATION

Complete the steps provided in this section to install the eSATA PCI Express Card to use with the RAID System. The eSATA PCI Express Card provides a host computer with two Windows and Mac compatible eSATA ports.

System Requirements

- ✚ Windows 2000 with Service Pack 4 or later
- ✚ Windows XP with Service Pack 2 or later
- ✚ Windows 2003 with Service Pack 1 or later
- ✚ Mac OS 10.4.x or later
- ✚ An available PCI-Express slot
- ✚ CD-ROM or DVD-ROM drive

Hardware Installation

1. Power “off” and unplug your computer.
2. Remove the housing of your computer and locate an available PCI-Express slot on your motherboard.
3. Insert the card in the available PCI-Express slot. Ensure that the card is firmly seated in the slot.
4. Replace the housing of your computer.

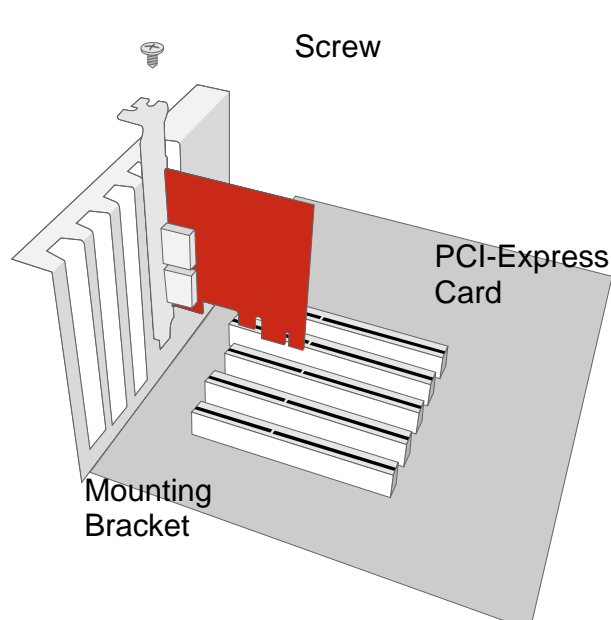

Driver Installation

Follow the provided prompts to complete the driver installation.

For the Windows system, the “Add New Hardware Wizard” will open automatically. Insert the installation CD included in the package, navigate to and open the installation file.

For Mac OS, insert the installation CD and locate the Mac driver installation file. Follow the provided instructions to complete the driver installation.



Please refer to User’s Manual under eSATA Host Card section on our website.

Verify Driver Installation

Mac OS:

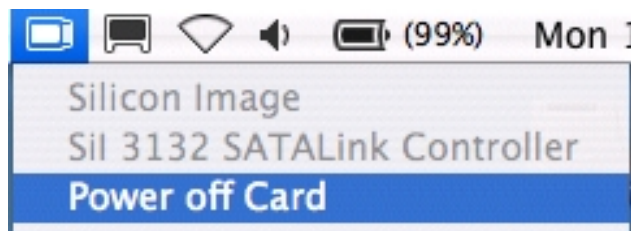

If a driver installation failure error message appears after restarting the computer, follow the recommendations provided in the error message.

Windows OS:

1. Right-click the **My Computer** icon on your desktop and choose **Manage** from the pop-up menu.
2. Double-click **Device Manager**.
3. Double-click **SCSI** and **RAID** controllers.
4. Verify that the **Sil 3132 SATALink Controller** appears, as shown below.

Windows 2003 and XP:

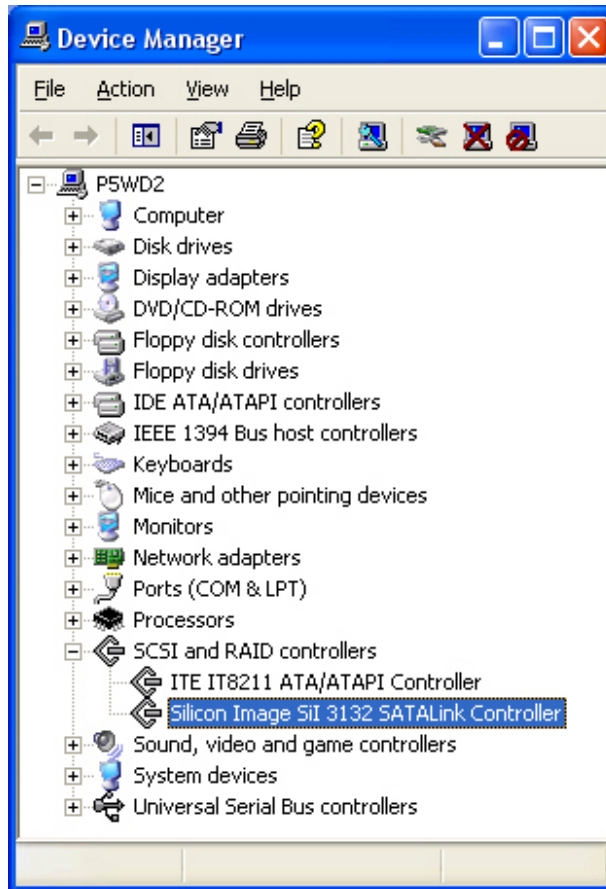

Windows 2000:

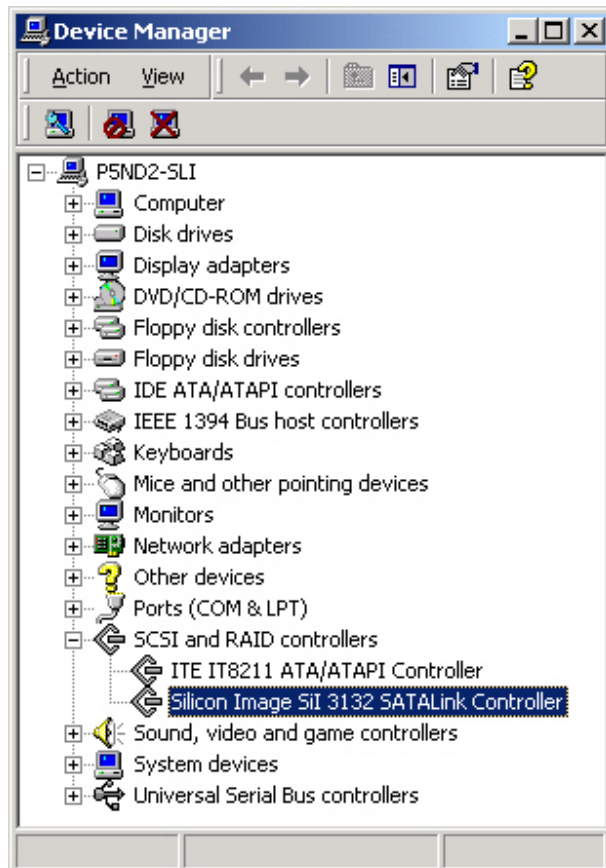

Q&As

General

Q: When I have finished changing the RAID mode, how come the System cannot accept the change and is still in the previous mode?

A: To make sure that the System accepts the RAID mode changes, you will need to power off the System first. When you power it back on, the System will accept the changes. It is highly recommended to always power off the RAID System before setting or changing the RAID Mode Switch to ensure that the changes are accepted by the System. Please be cautioned that changing the RAID mode can delete all data in the System.

HDD Capacity

Q: All my HDDs are at least 1TB or above, will the RAID System be able to support the gigantic storage capacity?

A: Yes, the RAID System will be able to support any HDDs over 1TB size capacity. However, most older host systems cannot support over 2TB of total capacity, only Mac OS 10.3 and newer, and PC Windows Vista or newer. In addition, based on the host system you have, there may be limitations on the port connections when the storage size is over 2TB. Please see the chart below.

OS		USB	FireWire	eSATA
Windows	Windows 2000, XP, or older	No	No	No
	Windows XP 64-bit, Windows 2003 32-bit/64-bit (SP1 and SP2)	Yes	No	Yes
	Windows Vista, Windows 2008 32-bit/64-bit	Yes	Yes	Yes
Linux	Linux 32-bit/64-bit	No	No	No
Mac	Mac OS 9/10.1/10.2	No	No	No
	Mac OS 10.3/10.4/10.5	Yes	Yes	Yes

Q: I would like to format my hard drives with the FAT (a.k.a. File Allocation Table) format, which can be read and written by both Mac and PC. Is there any limitation on its capacity?

A: Yes, please check the table below for reference.

File System	NTFS	FAT32	FAT (Format by Win2000 / WinXP)	FAT16
Capacity Limitation	Vista: 16384TB XP: 2TB	Windows: 32GB Mac: 2TB	4GB	2GB

Discrepancy in Reported & Actual Size Capacity

Q: If I have a 750GB HDD, why does the RAID System only recognizes the HDD available space as to be less than 750GB?

A: Many customers are confused by their host systems when it reports a discrepancy between reported capacity and actual capacity. Several factors can come into play when your host system views and reports the capacity of a hard drive. There are actually two different numbering systems used to express units of storage capacity:

Binary, which says that a kilobyte is equal to 1024 bytes; and
Decimal, which says that a kilobyte is equal to 1000 bytes.

Most commonly used to display storage capacity is in Decimal. The surprising fact is that even though it seems like you will have more bytes under Binary, the Decimal calculation system actually presents a greater storage capacity. More description on capacity issues can be found at the Seagate website under FAQs.

http://www.seagate.com/ww/v/index.jsp?locale=en-US&name=Storage_Capacity_Measurement_Standards_-_Seagate_Technology&vgnnextoid=9493781e73d5d010VgnVCM100000dd04090aRCRD

HDD Allocation

Q: I've pulled out all the disks inside the RAID System and now I want to put them back, but I don't remember the HDD allocation. Will my data be safe if I put the HDDs back into the RAID System if they're not in the correct allocation?

A: No, it would NOT be safe for your data if the HDDs were not placed back into the RAID System in their original arrangement order. We would highly recommend all users to use the number stickers in the package to help identify which HDD belongs to which HDD slot. You may stick them onto the handles or HDDs as identification.

HDD Allocation

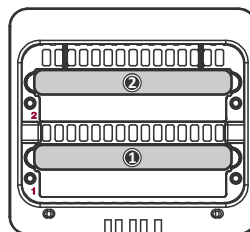

RAID 0

Q: I am using one HDD in the capacity of 750GB and another HDD in the capacity of 500GB under the RAID 0 mode. Why is the total capacity not 750GB + 500GB?

A: Using identical HDDs with the same capacity and RPM, and from the same manufacturer are highly recommended for BEST capacity utilization.

JBOD

Q: I cannot do the JBOD under the eSATA connection? Why?

A: Due to the chipset design, the JBOD mode cannot be performed under the eSATA connection.

Q: I have inserted one HDD under the USB connection, but the system cannot recognize it. Why?

A: Please insert the HDD into the HDD 2 of the HDD slots instead of HDD 1.

APPENDIX: SPECIFICATIONS

Model Name	RS-M2QO
Connector	eSATA x 1, USB 2.0 x 1, 1394a x 1, 1394b x 1
HDD Support	3.5" SATA HDD* *Identical HDD recommended – same manufacturer, capacity and RPM
RAID Level	RAID 0 (Striping), RAID 1 (Mirroring), JBOD
Data Transfer Speed	eSATA: up to 3Gbit/sec USB 2.0: up to 480Mbit/sec 1394a: up to 400Mbit/sec 1394b: up to 800Mbit/sec
System Material	Aluminum case with plastic parts
LED Indicators	Power / Connection / Health / Access / Rebuild
Power Supply	Input: AC 90-264V Output: DC +12V/2A, +5V/2A Peak current: 4A, 3.7A
FAN	Dimension: 80 x 80 x 10 mm x 1 Speed: 1900 R.P.M +-10% Noise: 17.13 dB(A) max
Dimension	126 (L) x 138 (W) x 213 (H) mm
Weight (without HDD)	1.35 KGS
Certification	CE, FCC